

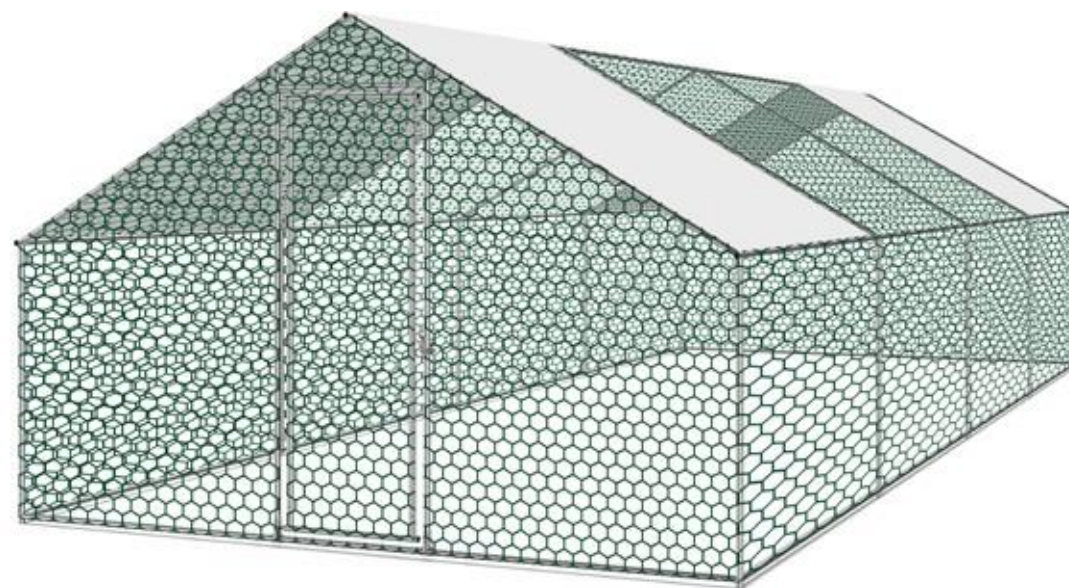























# ENCLOS

## 3x8x2m

### NOTICE DE MONTAGE

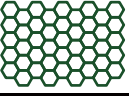

PARTIE	DESCRIPTION	PHOTO	QUANTITE
①	1870mm		20
②	1410mm		4
③	970mm		10
④	1650mm		10
⑤	560mm		2
⑥	660mm		1
D1			1
D2	1470mm		1
D3	1750mm		1
A			4
B			2
C			6

PARTIE	DESCRIPTION	PHOTO	QUANTITE
D			6
E			9
F			2
G			4
H			4
I			4
J			10
K			10
L			/
M			/
N			24m x1 + 36m x1
O			2

## 1. ASSEMBLAGE DE LA BASE



A x4



B x2



C x6



Tube 1 x8



Tube 2 x4

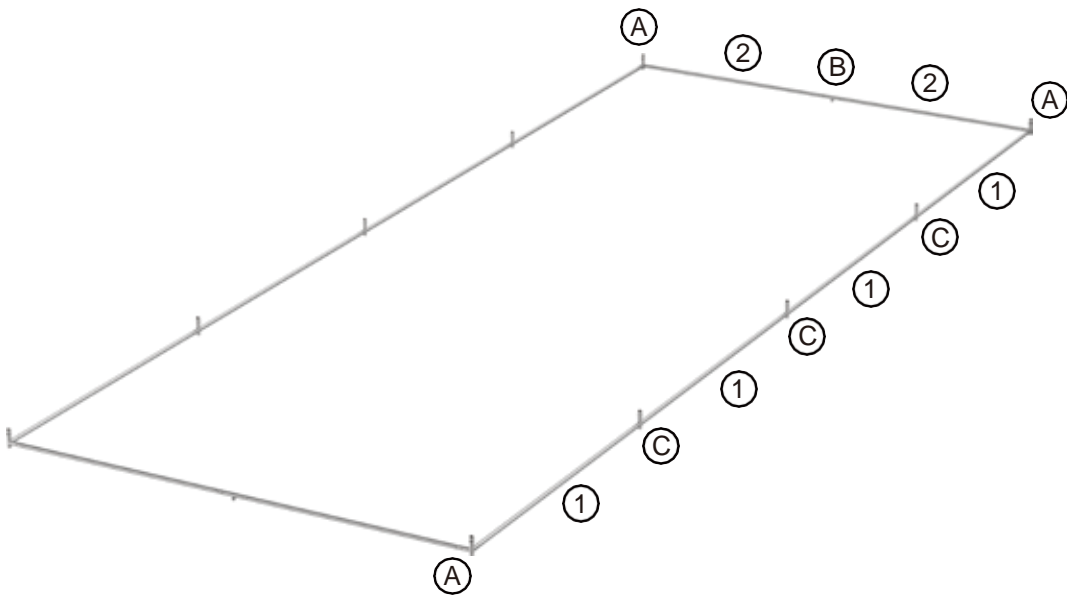

## 2. ASSEMBLAGE DES TUBES VERTICAUX



Tube 3 x10

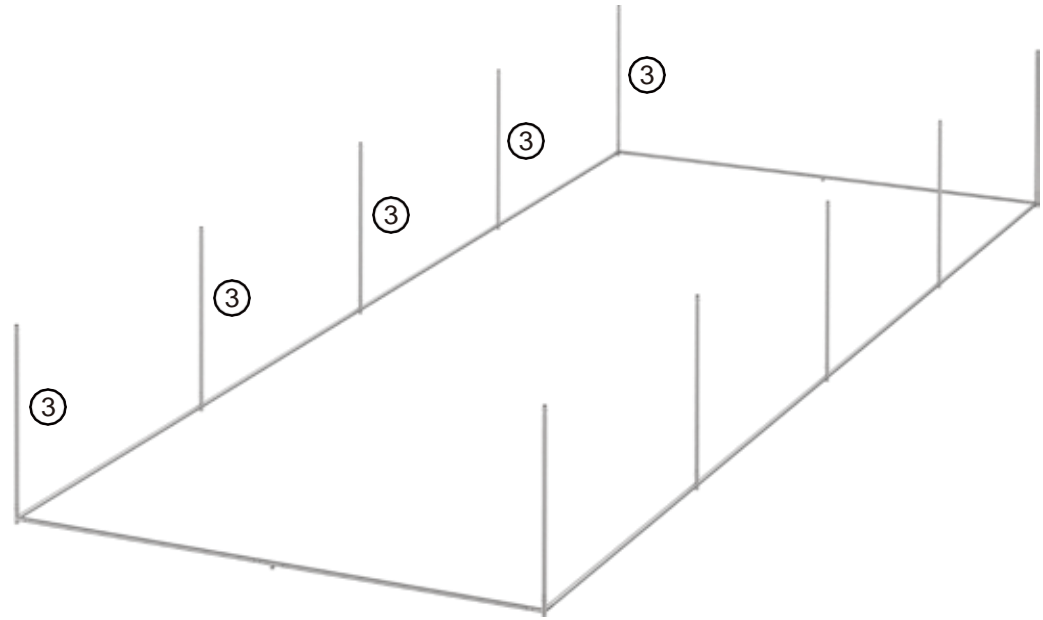

### 3. ASSEMBLAGE DE LA STRUCTURE DU TOIT

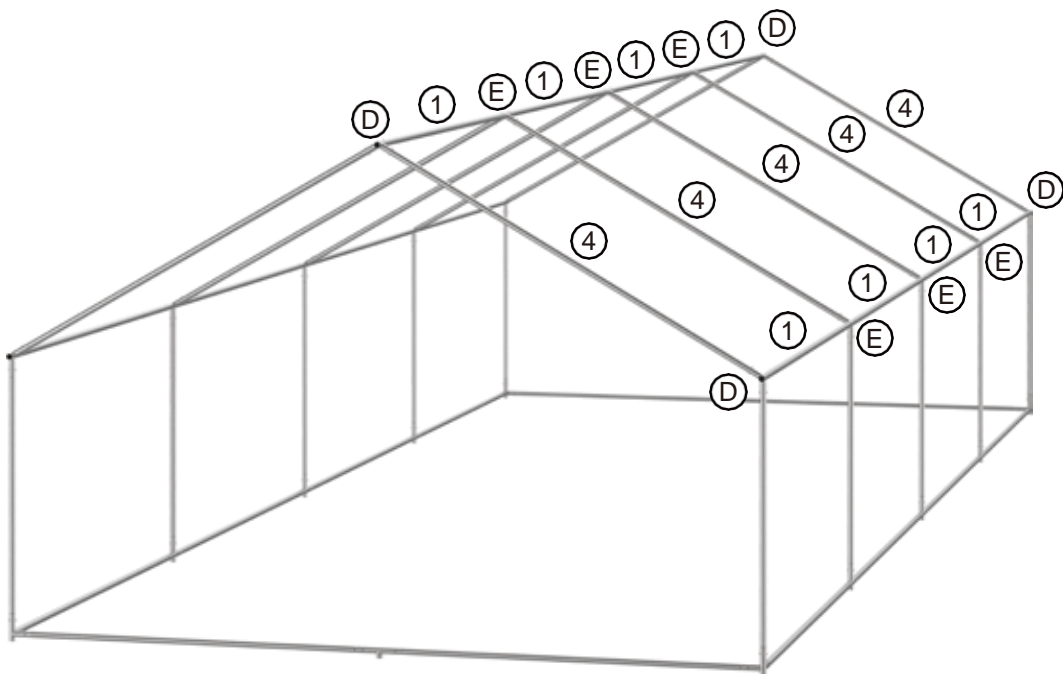
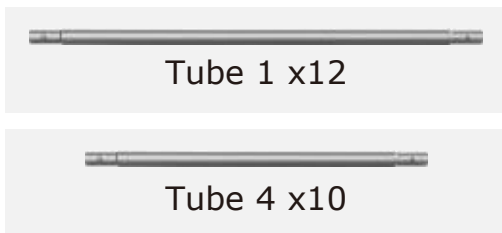

### 4. ASSEMBLAGE DE LA PORTE

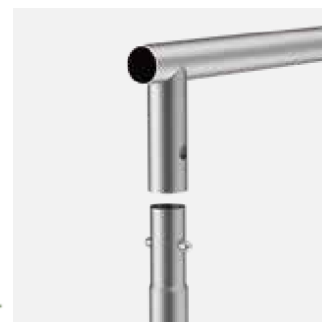
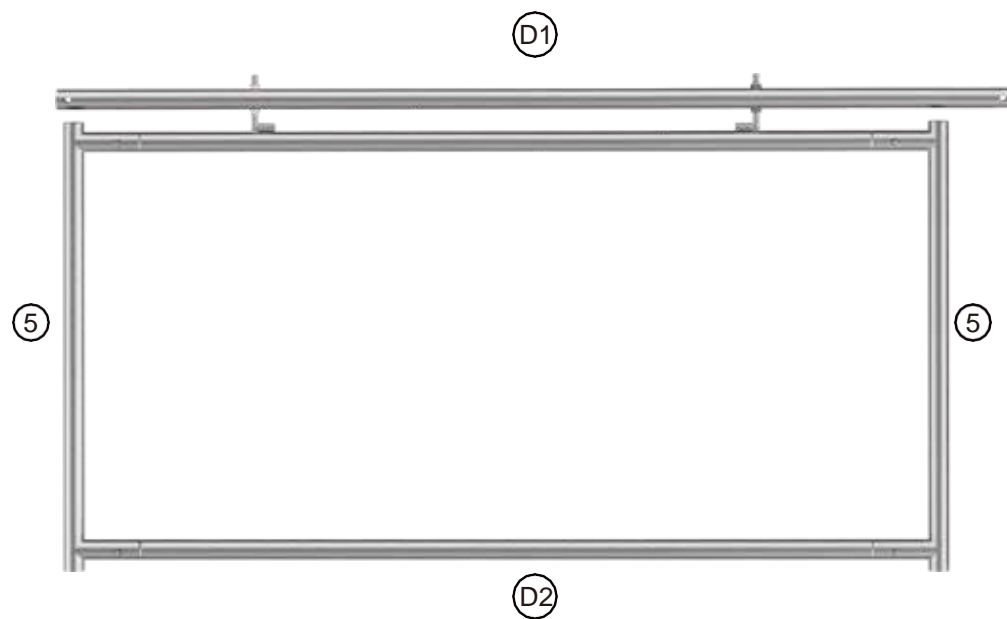
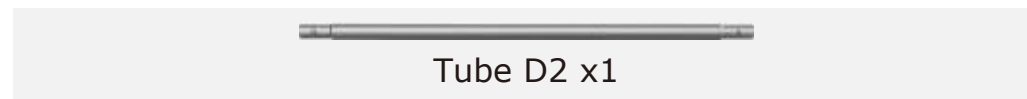
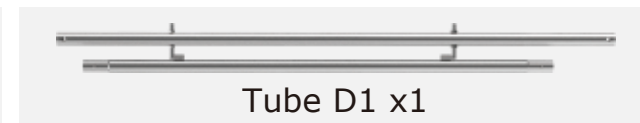
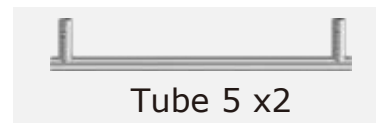

## 5. MISE EN PLACE DE LA PORTE



F x2



G x4



H x4



Tube D3 x1



Tube 6 x1

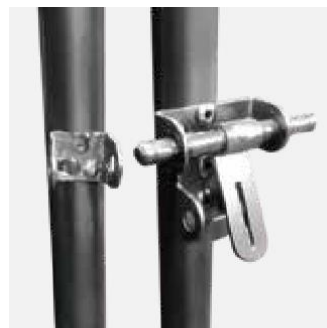
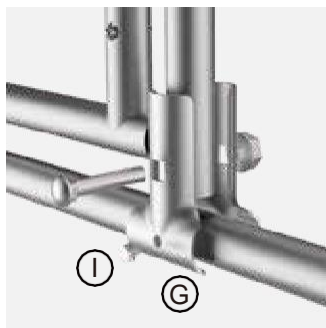
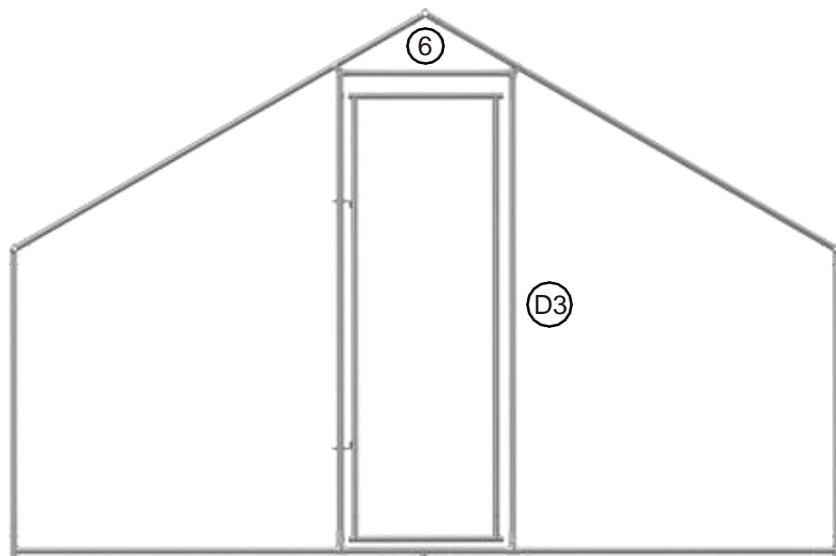

## 6. INSTALLATION DU GRILLAGE

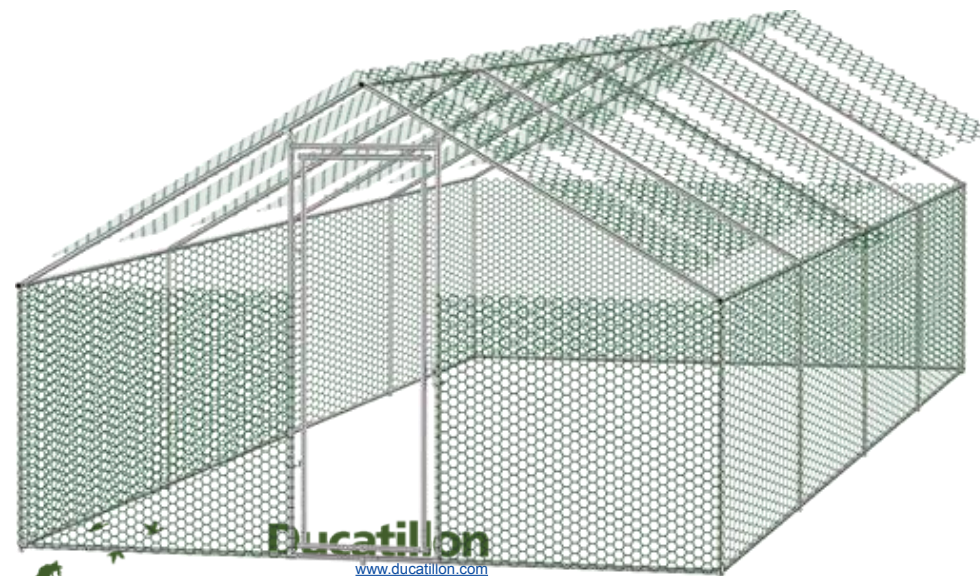
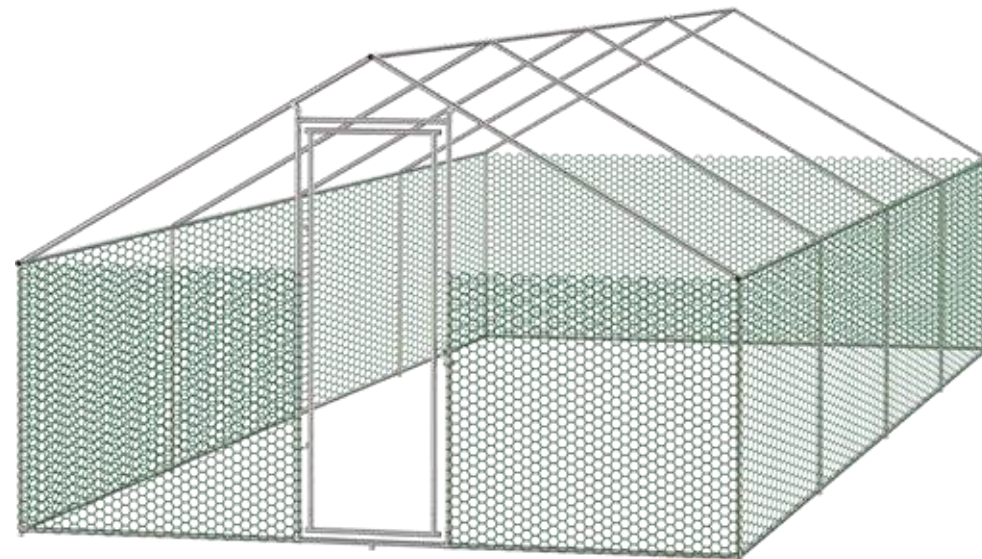

Ducatillon  
[www.ducatillon.com](http://www.ducatillon.com)

## 8.INSTALLATION DU TOIT

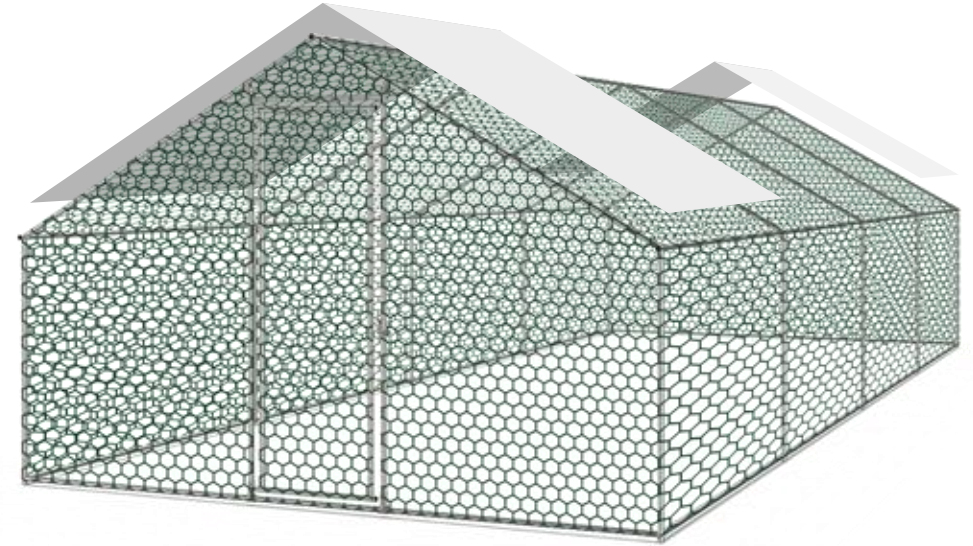
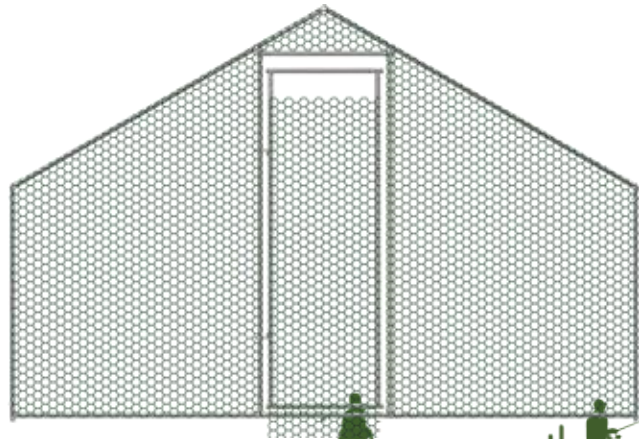
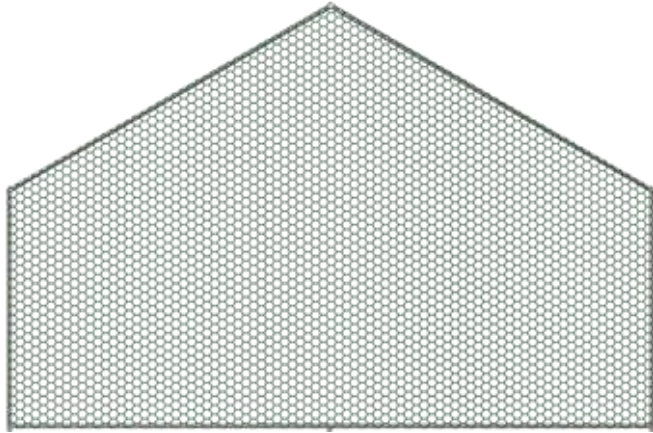
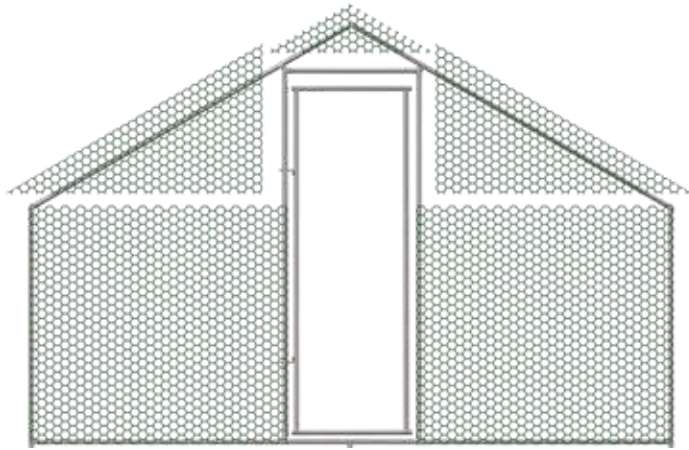

Chasse

Pêche

Loisir et nature

Jardin

Élevage

**Ducatillon**  
[www.ducatillon.com](http://www.ducatillon.com)