

























# ENCLOS

## 3x4x2m

### NOTICE DE MONTAGE

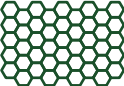

PARTIE	DESCRIPTION	PHOTO	QUANTITE
①	1870mm		10
②	1410mm		4
③	970mm		6
④	1650mm		6
⑤	560mm		2
⑥	660mm		1
D1			1
D2	1470mm		1
D3	1750mm		1
A			4
B			2
C			2

PARTIE	DESCRIPTION	PHOTO	QUANTITE
D			6
E			3
F			2
G			4
H			4
I			4
J			10
K			6
L			/
M			/
N			36mx1
O			1

# 1.ASSEMBLAGE DE LA BASE

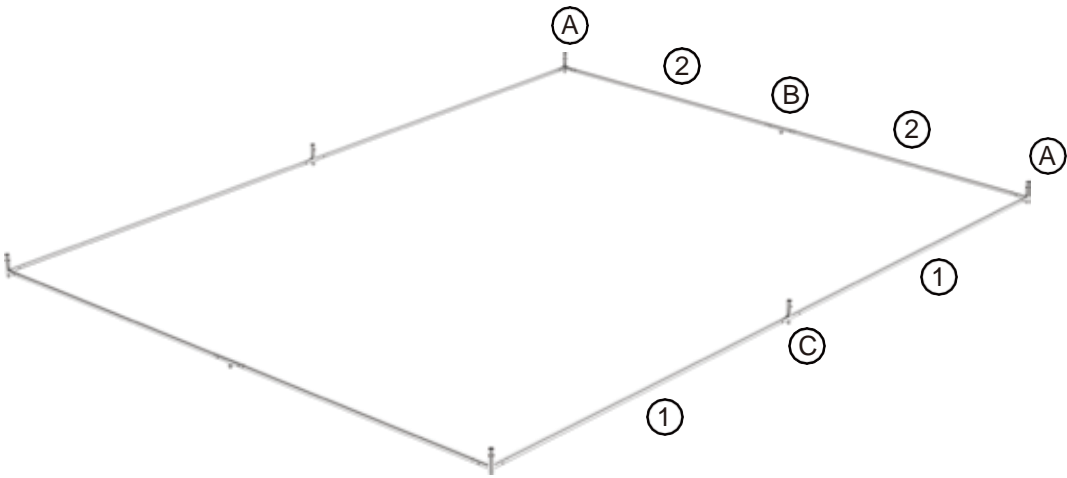
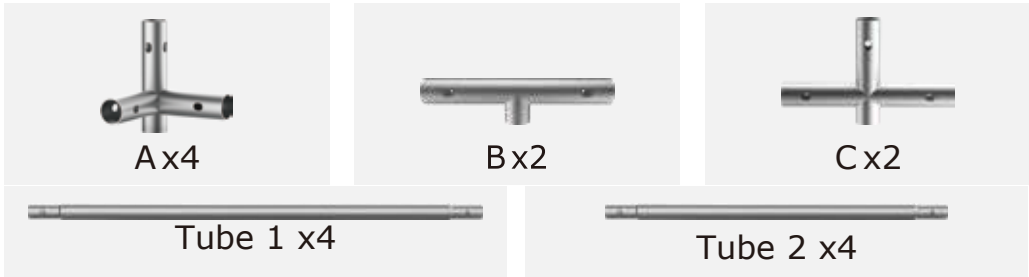

# 2.ASSEMBLAGE DES TUBES VERTICAUX

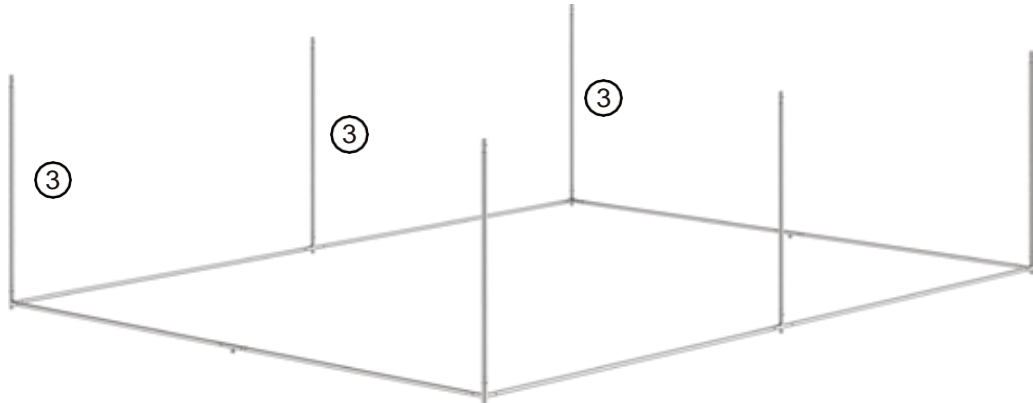
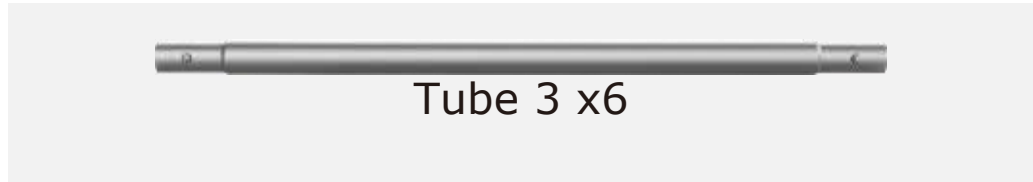

### 3. ASSEMBLAGE DE LA STRUCTURE DU TOIT

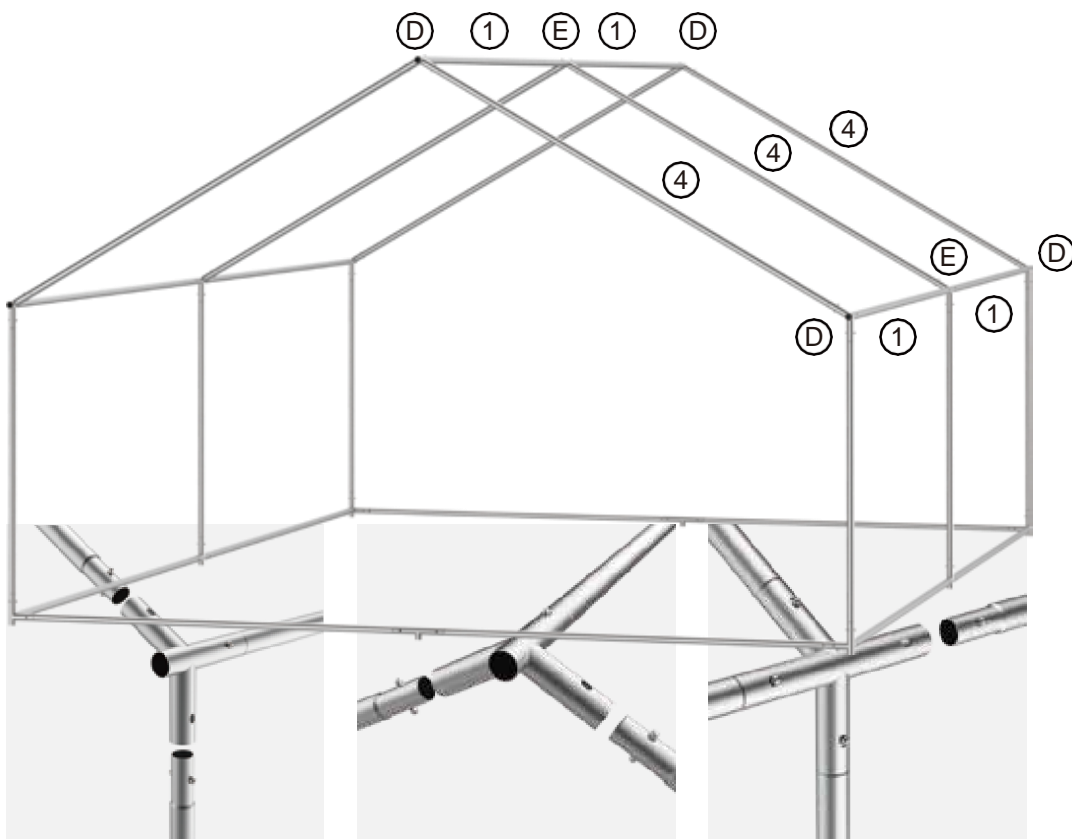
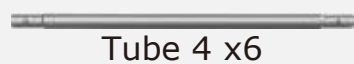
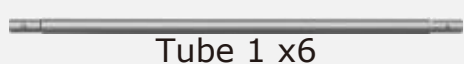

### 4. ASSEMBLAGE DE LA PORTE

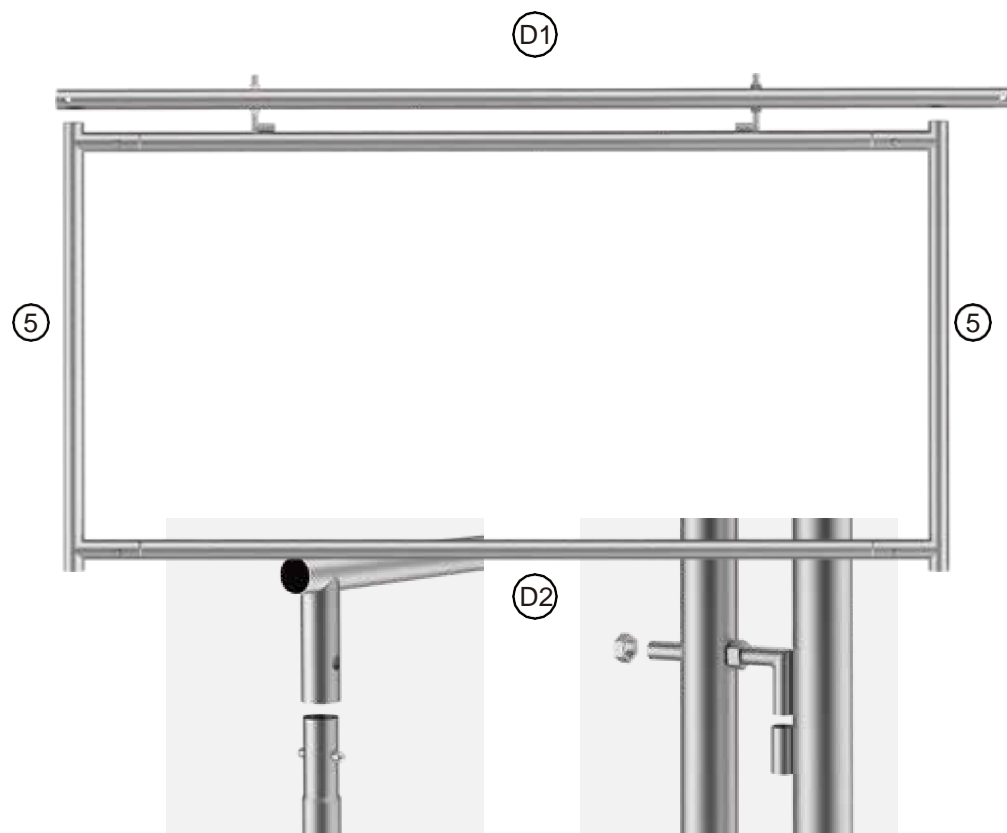
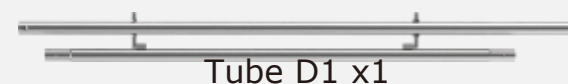
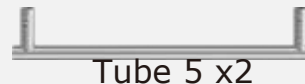



## 5. MISE EN PLACE DE LA PORTE



F x2



G x4



H x4



J x4



Tube D3 x1



Tube 6 x1

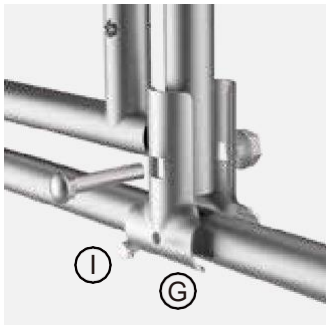
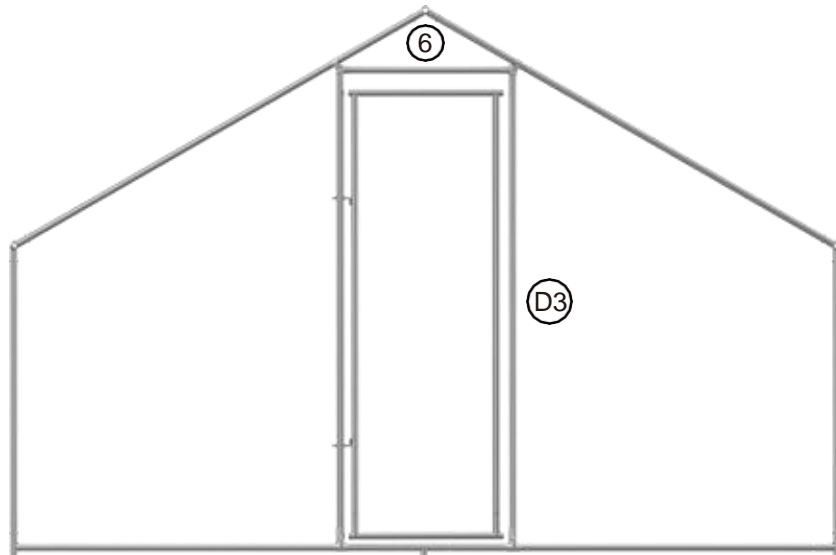

## 6. INSTALLATION DU GRILLAGE

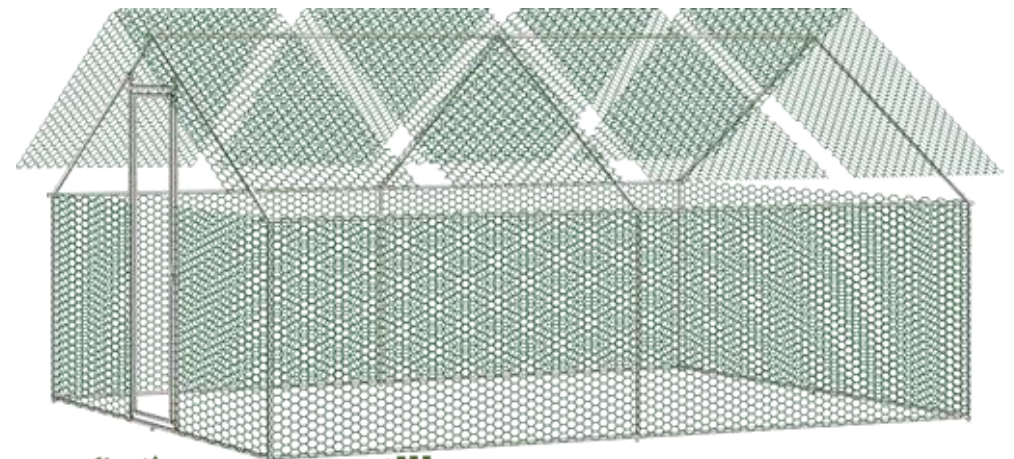
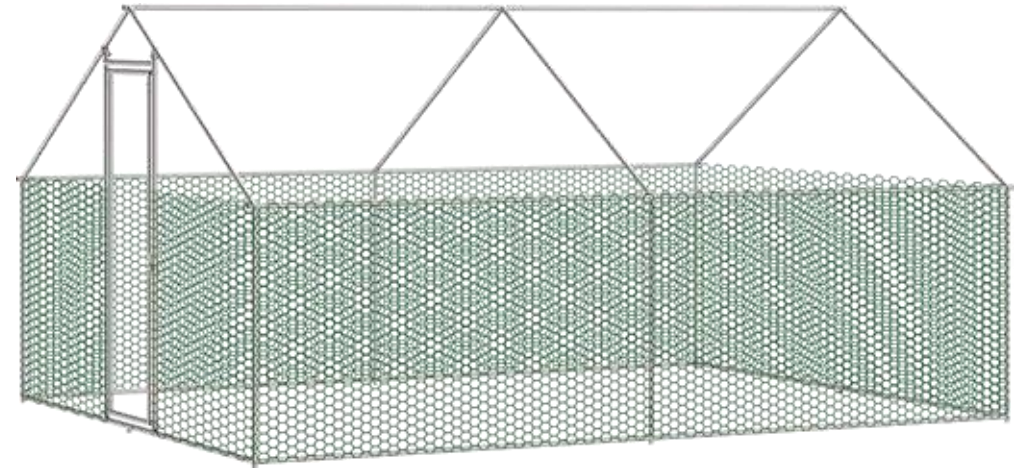

**Ducatillon**  
[www.ducatillon.com](http://www.ducatillon.com)

## 7. INSTALLATION DU TOIT

